

PJ703 Screen Stock

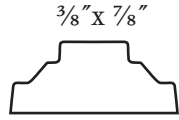

PJ702 (NORCO Grill)

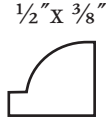

PJ734

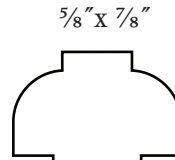

PJ741

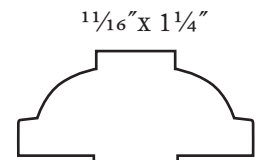

PJ742

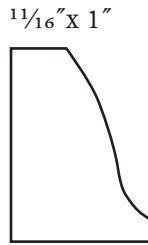

PJ713

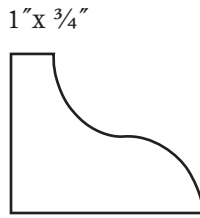

PJ708

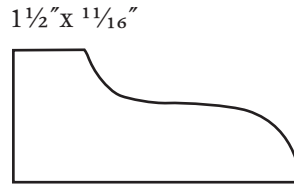

PJ709

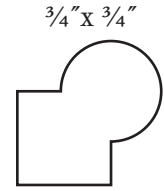

PJ738
(pencil moulding)

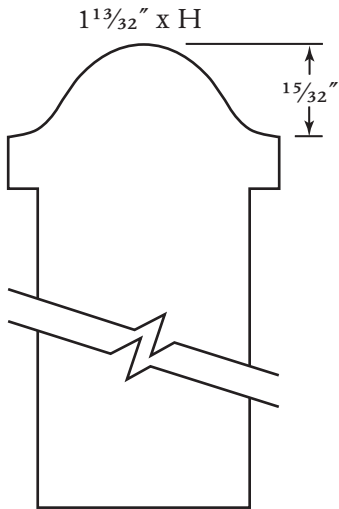

PJ746

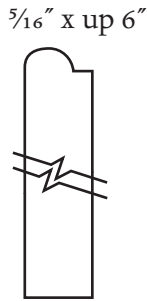

PJ729

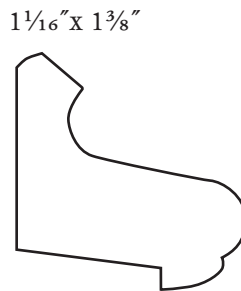

PJ732

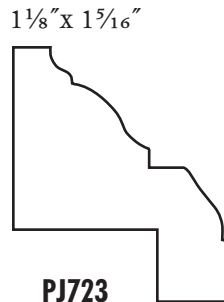

PJ723

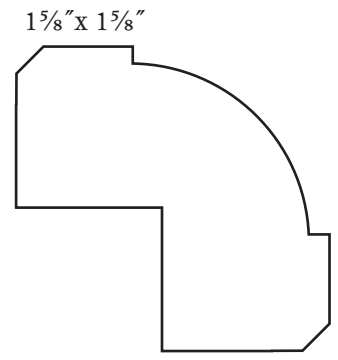

PJ745
(required 7/8" router bit)



PJ720



PJ712

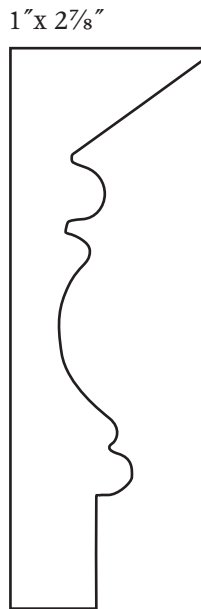

PJ722

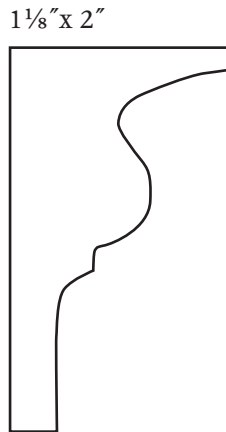

PJ721

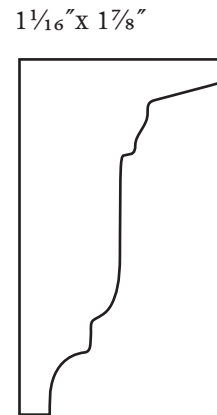

PJ710

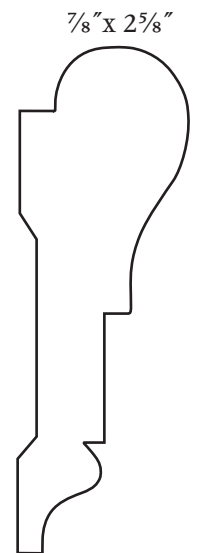

PJ717

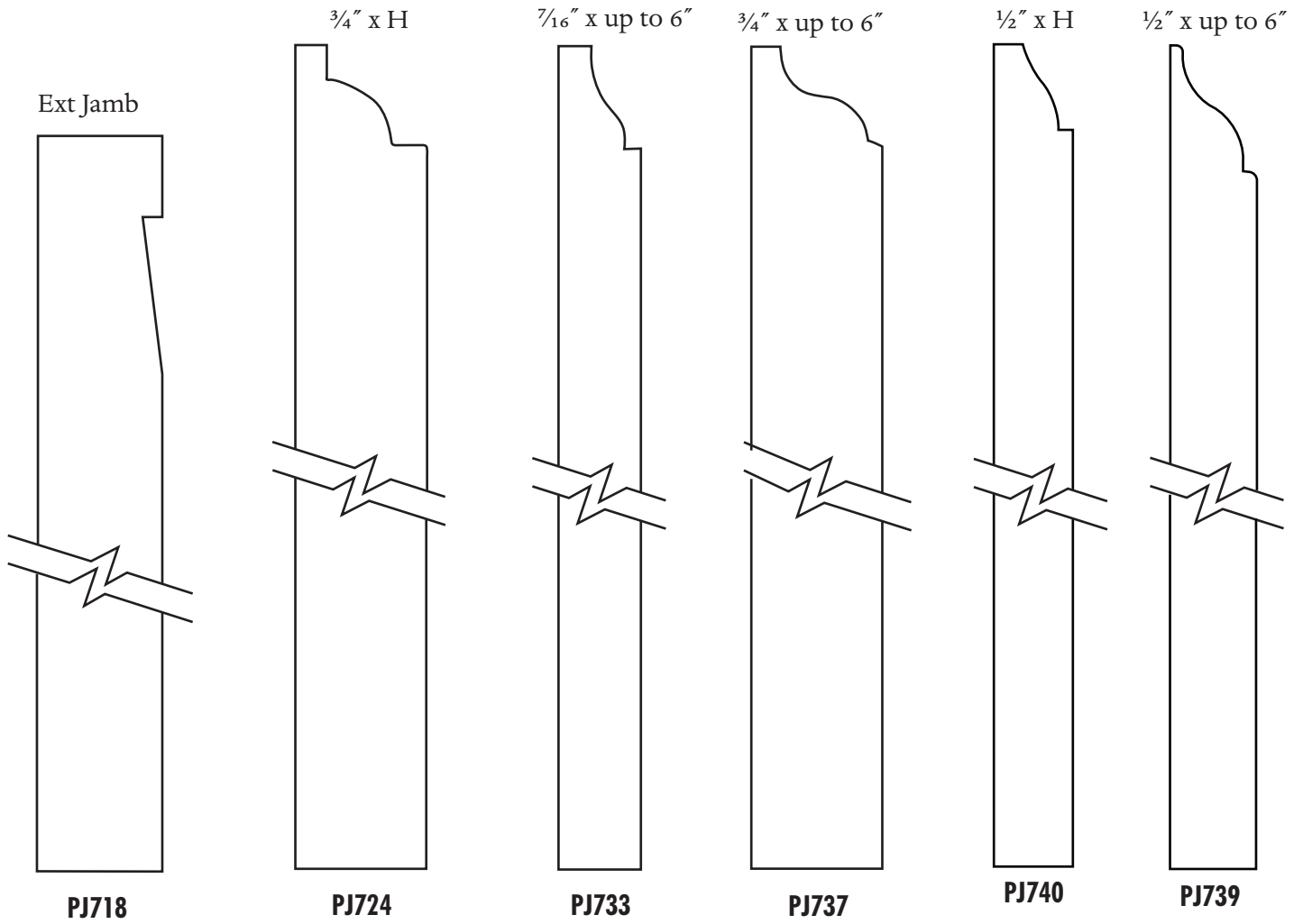

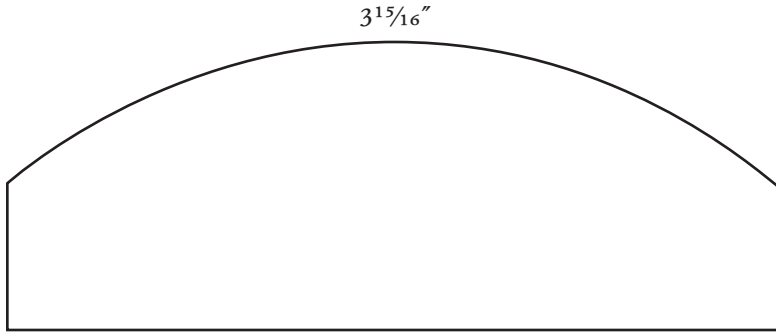

PJ716

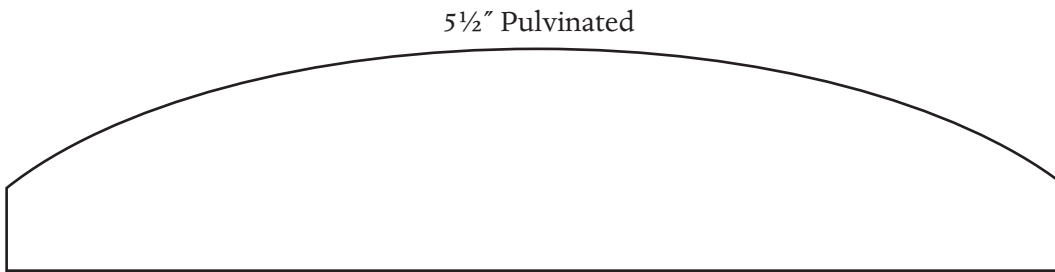

PJ711

$1\frac{1}{16}'' \times 2\frac{1}{8}''$

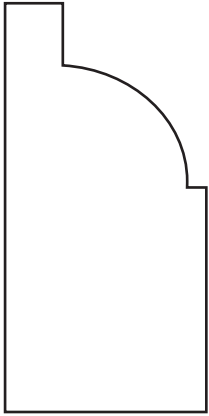

PJ744

$1\frac{1}{2}'' \times 2\frac{3}{4}''$

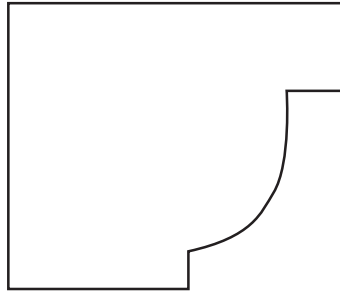

PJ748

$1\frac{5}{16}'' \times \frac{5}{8}''$



PJ743

$\frac{5}{8}'' \times \frac{7}{8}''$

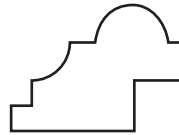

PJ747

$1\frac{3}{16}'' \times 4\frac{1}{8}''$

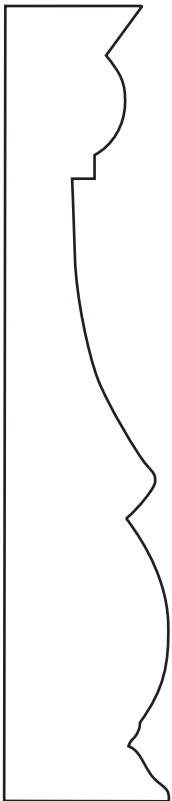

PJ749

$\frac{3}{4}'' \times 4\frac{7}{8}''$

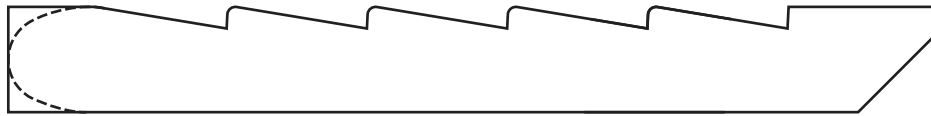

PJ750 Birdhouse Roof